



## **SEISMIC VULNERABILITY ASSESSMENT OF PRE-CODE FRAME BUILDING RETROFITTED USING BUCKLING RESTRAINED BRACES**

Anas S. Issa <sup>1,4</sup>, Aman Mwafy <sup>2</sup> and M. Shahria Alam <sup>3</sup>

<sup>1</sup> Graduate Research Assistant. The University of British Columbia, Kelowna, BC, Canada

<sup>2</sup> Associate Professor. United Arab Emirates University, Al Ain, UAE

<sup>3</sup> Associate Professor. The University of British Columbia, Kelowna, BC, Canada

<sup>4</sup> [anas.issa@alumni.ubc.ca](mailto:anas.issa@alumni.ubc.ca)

### **ABSTRACT**

A systematic seismic vulnerability assessment of a benchmark 8-story structure representing pre-seismic code frame buildings in a highly populated and seismically active area is conducted in this study. Detailed structural design and fiber-based modeling are carried out for the reference structure. Forty earthquake records are selected to represent potential earthquake scenarios in the study area. A large number of inelastic pushover analyses (IPAs) and incremental dynamic analyses (IDAs) are performed to select the performance criteria and to derive fragility relationships for the reference building. It is concluded that this category of pre-code structures is substantially vulnerable to seismic loads. The derived fragility curves for the retrofitted reference structure using Buckling Restrained Braces (BRBs) proved that such technique is efficient in reducing the seismic losses of pre-code frame structures and increasing public safety.

Keywords: vulnerability assessment, pre-code RC frames, seismic retrofit, inelastic dynamic simulations, BRB.

### **1. INTRODUCTION**

Pre-seismic code buildings usually undergo low levels of strength and ductility as they were designed and constructed without proper seismic design provisions. Earthquake loss mitigation of the substandard structures represented in the building inventory may require the adoption of efficient retrofit techniques. The mitigation measures include for instance: Reinforced Concrete (RC) jacketing, Fiber Reinforced Polymers (FRP) wrapping, installing bracing systems, adding new shear walls, and use of Externally Unbonded Steel Plates (EUSP), (e.g. Moehle 2000). Such mitigation measures can upgrade the seismic response of structures to higher performance levels. Dubai, UAE, is selected in the present study to represent regions of medium seismicity with diverse buildings and seismic scenarios. Recent seismic events in the UAE indicated that the region is prone to earthquakes that may cause damage to substandard structures (e.g., USGS 2014). Although no human or monetary losses were reported from recent events, the repeated earthquakes have raised concerns regarding the vulnerability of the pre-seismic code building stock in the region and the associated risk. Non-negligible consequences are expected if the seismic risk of the building stock is overlooked, particularly for substandard buildings. Few vulnerability and seismic loss assessment studies have been carried out recently for the UAE (e.g. Mwafy et al. 2015). For instance, a systematic seismic vulnerability assessment of a diverse range of buildings representing the pre-seismic code structures in a highly populated and seismically active area in the UAE has been recently undertaken (Issa and Mwafy 2014). However, previous studies have not considered the impact of efficient mitigation approaches on reducing the seismic risk using a wide range of input ground motions representing different seismic scenarios. This underlines the pressing need for seismic vulnerability assessment of proper retrofit techniques for the pre-seismic code buildings that can be applied on a regional scale.

The present study thus focuses on the seismic vulnerability assessment of a RC multistory structure representing pre-seismic code frame buildings in medium seismicity regions represented by the UAE. This enables the direct implementation of fragility relationships that represent different earthquake scenarios in a loss estimation and hazard mitigation system for the study region. The probabilistic study also explores the efficiency of a seismic retrofit technique for reducing the potential seismic losses of this category of buildings.

## 2. REFERENCE BUILDING

The reference structure is selected in the present study to represent the pre-code buildings inventory in medium seismicity regions represented by a highly populated and seismically active area in the UAE, namely Dubai, Sharjah, and Ajman. The building inventory data of this area was collected in another study by means of site visits and high-resolution satellite images (A.M. Mwafy, 2012). Many of the old buildings in the study area were not designed to resist seismic loads since the UAE was classified as zone '0' as per the UBC provisions (1997). Revised seismic design criteria have been adopted later in the UAE based on recent seismic hazard studies (e.g., A. M. Mwafy et al., 2006). Based on the above-mentioned survey, a pre-code RC frame building of 8 stories is selected and fully designed for the purpose of this study, as shown in Table 1 (BS8110, 1986; A. Issa & Mwafy, 2014a). The three-dimensional finite element models developed for the design of the reference building as well as the floor plan are shown in Figure 1.

Table 1. Summary of the selected reference buildings.

Building Reference	No. of stories	Story height (m)			Total height (m)
		B	GF	TF	
BO-08	8	-	5.0	3.5	28.5

B: Basement, GF: Ground Floor, TF: Typical Floor

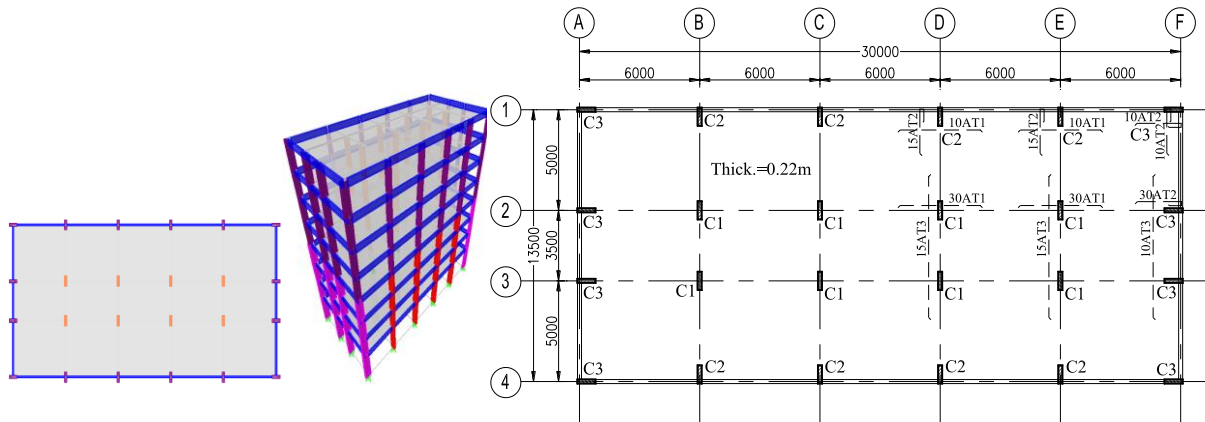

Figure 1. Layouts and three-dimensional design model of the reference structure.

The three-dimensional finite element model employed in the design was developed for the building investigated in the present study using the structural analysis and design software ETABS (CSI, 2011). The pre-seismic code building is designed and detailed specifically for the purpose of the current study according to the building codes that were implemented at the time of construction (BS8110, 1986). The Pre-seismic code buildings are defined as those built in the study area before 1991 when seismic design provisions might be disregarded. As discussed earlier, the UBC provisions (1997) recommended the use of Seismic Zone '0' for the cities of Abu Dhabi and Dubai, UAE. Therefore, wind loads are the only lateral loads considered in the design of the pre-code structure to represent the real situation before 1991 (BS8110, 1986).

The permanent loads used in the design of the pre-code building include the superimposed dead load of 4.0 kN/m<sup>2</sup> and the self-weight of structural members. The live load is 2.0 kN/m<sup>2</sup>, except for staircases and exit ways which are 4.8 kN/m<sup>2</sup>. The design is carried out carefully for the building to obtain the

optimum cross sections for different structural elements. To accurately represent the pre-code structure, the material properties that were utilized at the time of construction were considered. The concrete strength is 20 MPa in vertical and horizontal elements. Mild steel is used in the design with a yield strength of 240 MPa. Pre-code buildings with such material properties are likely to be more vulnerable to earthquake loads due to the large cross sections, heavy mass and inadequate detailing as compared to modern code-designed structures. The iterative design process was adopted to obtain the most efficient and economic design that has a demand-to-capacity (D/C) ratio close to unity. Figure 2 shows cross-sections for the different columns used in the design of the reference 8 story building. The design summary of vertical members is shown in Table 2.

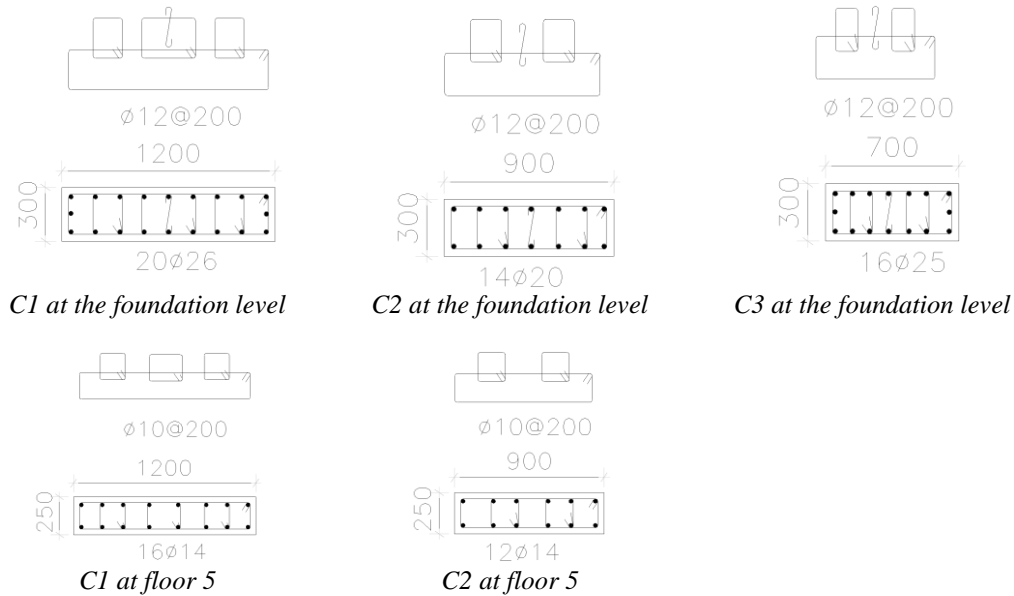

Figure 2. RC cross-sections used in the design of the 8-story building

Table 2. Vertical members design summary of the reference 8-story building

Section	C1		C2		C3
Location of section	Foundation level	5 <sup>th</sup> story	Foundation level	5 <sup>th</sup> story	All stories
Vertical steel ratio ( $\mu\%$ )	2.9%	1.00%	1.63%	1.00%	3.74.%
VL. Reinforcement	20#26	16#14	14#20	12#14	16#25
HL. Reinforcement	#12@200mm	#10@200mm	#12@200mm	#10@200mm	#10@200mm
(D/C) Ratio	0.967	0.721	0.93	0.645	0.81
Pier section mm x mm	300x1200	250x1200	300x900	250x900	300x700
( $f_c'$ ) MPa	20	20	20	20	20

### 3. GROUND MOTIONS

The dynamic behavior of a structure during an earthquake depends on the characteristics of the applied earthquake records. Thus, input ground motions are a key component of seismic risk studies as they significantly affect the output results of the fragility curves. Ground motion parameters that are of interest include PGA, the ratio of peak ground acceleration-to-velocity ( $a/v$ ), soil condition, magnitude and epicentral distance. There are three types of ground motion records: (i) real records, which are recorded from seismic monitoring stations; (ii) synthetic records, which are generated using seismological models with pre-determined ground motion parameters; and (iii) artificial records, which are generated to match a target spectrum (Yamamoto & Baker, 2013). When performing a seismic risk study, it is preferable to use real ground motions retrieved from local and regional sources in the area of interest.

Therefore, two sets of earthquake records representing the study area were selected for inelastic dynamic simulations. Both the PEER Ground Motion Database (PEER, 2013) and the European Strong-Motion Database (Ambraseys et al., 2004) were thoroughly searched to select 40 natural records that represent the earthquake scenarios related to the study region, namely far-field records and near-source events (e.g. Mwafy et al., 2006). Basically, the selection was conducted in two stages. Stage one: initial filtering, and stage two: final selection based on the recommended design response spectra. For stage one, the filtering of databases was carried out according to pre-defined criteria which represent site-specific properties. These criteria are: (i) epicentral distance, (ii) magnitude, (iii) soil condition, (iv) PGA, and (v) a/v ratio. The above-mentioned criteria, however, represent the first stage of attaining the natural records, which resulted in about 500 records. Stage two included plotting the spectral acceleration for each of these records against the design code spectra of the study area (ADIBC, 2013). The response spectra of the selected records were extracted and scaled to the recommended design intensity of the study area (i.e. a PGA of 0.16g). In the latter stage, 20 near-source records matching the short period portion of the code response spectra and 20 far-field records matching the long period portion were selected for IDAs. The response spectra of the selected 40 input ground motions, that represent the near-source and far-field seismic scenarios with the current design spectra for the study area for soil classes C and D, are illustrated in Figure 3.

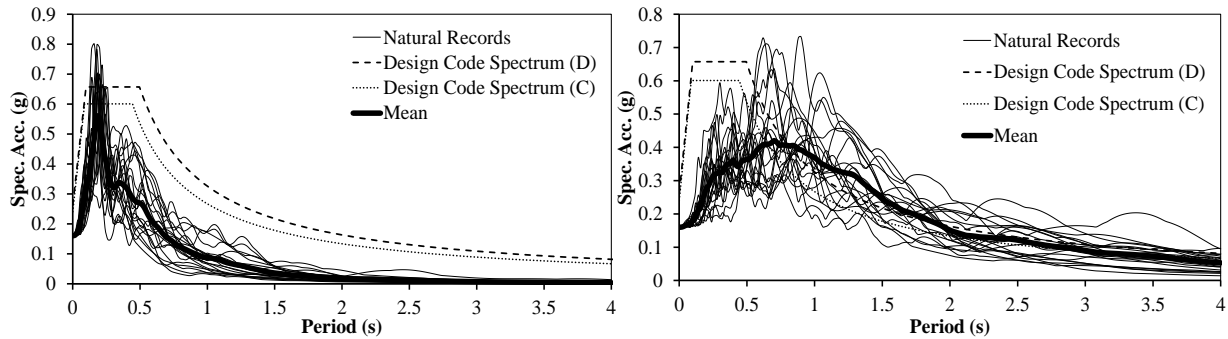

Figure 3. Response spectra of near-source earthquake records (Left) and far-field records (Right)

#### 4. INELASTIC ANALYSES

The reference structure is subjected to a series of Eigenvalue analyses, Inelastic Pushover Analyses (IPAs), and Incremental Dynamic Analyses (IDAs) to assess its dynamic characteristics, lateral capacity and seismic performance. Over 1000 inelastic multi-step analyses are performed using the multi-degree-of-freedom fiber-based numerical model of the benchmark building. The lateral capacity, Inter-story Drift Ratios (IDRs), plastic hinge distribution and shear response are monitored and compared. Three limit states are defined based on extensive IPA and IDA results as well as the values recommended in previous analytical and experimental studies and code provisions (A. Issa & Mwafy, 2014b). The IDA results are utilized to derive fragility relationships of medium-rise pre-code frame buildings in the UAE under two earthquake scenarios. The limit state exceedance probabilities are compared for different seismic scenarios to provide insights into the vulnerability of this class of buildings and the need for seismic hazard mitigation. Figure 4 shows a sample of the obtained results for the inelastic dynamic analyses conducted for the reference structure.

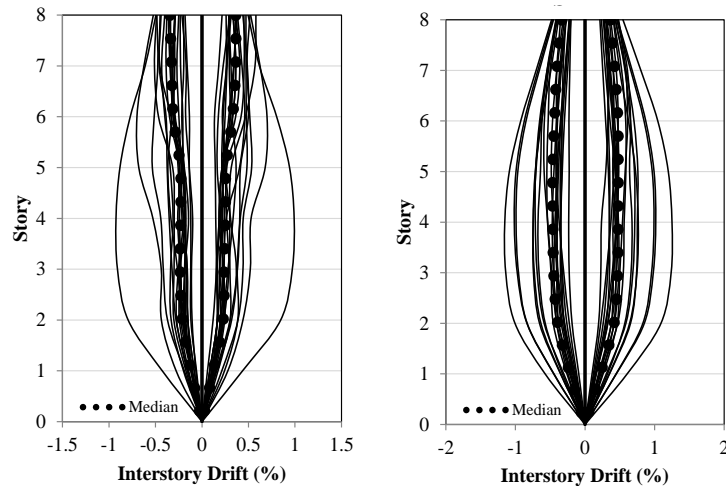

Figure 4: Distributions of maximum IDRs for the pre-code structure from IDA under forty earthquake records scaled to twice the design (0.32g for near-source records) and half the design (0.08 for far-field records) earthquake intensity

The inelastic pushover analysis was conducted for the case study building to estimate the lateral strength and deformation capacity, and to identify the possible failure mechanisms of the buildings. This analysis procedure reduces the computational effort significantly as compared with IDA, which requires the use of a wide range of input ground motions as well as scaling and applying each record incrementally up to collapse. Displacement-controlled pushover analyses are conducted for the fiber-based numerical model developed for the case study building. This analysis involves applying the gravity load to the structure and then applying increasing lateral loads. A predefined lateral load pattern such as uniform or inverted triangular loads is distributed along the building height. The analysis is carried out until a predefined limit state or a target displacement of the structure is attained while controlling the top displacement. With the incremental increase in the magnitude of lateral loading, probable weak areas along with failure modes of the structure can be spotted.

The pushover analysis is used to verify the structural performance of buildings, including the following purposes: (i) to estimate the lateral capacity of the structure by plotting the total base shear versus top displacement, which helps capturing premature weakness or failure; (ii) to estimate the distribution of inter-story drift that accounts for the lateral strength and stiffness; (iii) to estimate and verify the overstrength values at different strength levels; and (iv) to estimate the expected plastic hinges, damage and failure mechanisms to the structure. The response of the reference structure is examined using an inverted triangular lateral load pattern (PT). The PT load pattern represents the deformed shape of the structure when it vibrates in its fundamental mode. This load distribution is suitable for low-to-medium rise structure. The lateral strength, first yield in structural elements, global yield, and first local failure were monitored and mapped on the lateral capacity curves of the reference structures, as shown in Figure 5.

The global yield was evaluated from an elastic-perfectly plastic idealization of the capacity envelopes. The initial stiffness was estimated as the secant stiffness passing through the capacity envelope at 75% of the ultimate strength (Park, 1988). In this approach, it is considered that the global yield is the starting point of the post-elastic branch. The ultimate capacity of the structure is calculated at the maximum base shear, as shown in Figure 5. It was shown from the results that the steel yielding starts in vertical structural elements and is followed by horizontal elements in the reference structure, which represent deficiencies in pre-code structures. The results indicate that although the pre-code structure has acceptable IRDs at its ultimate strength, its deformation increases rapidly afterward. This is clear from the rapid strength degradation shown in Figure 5.

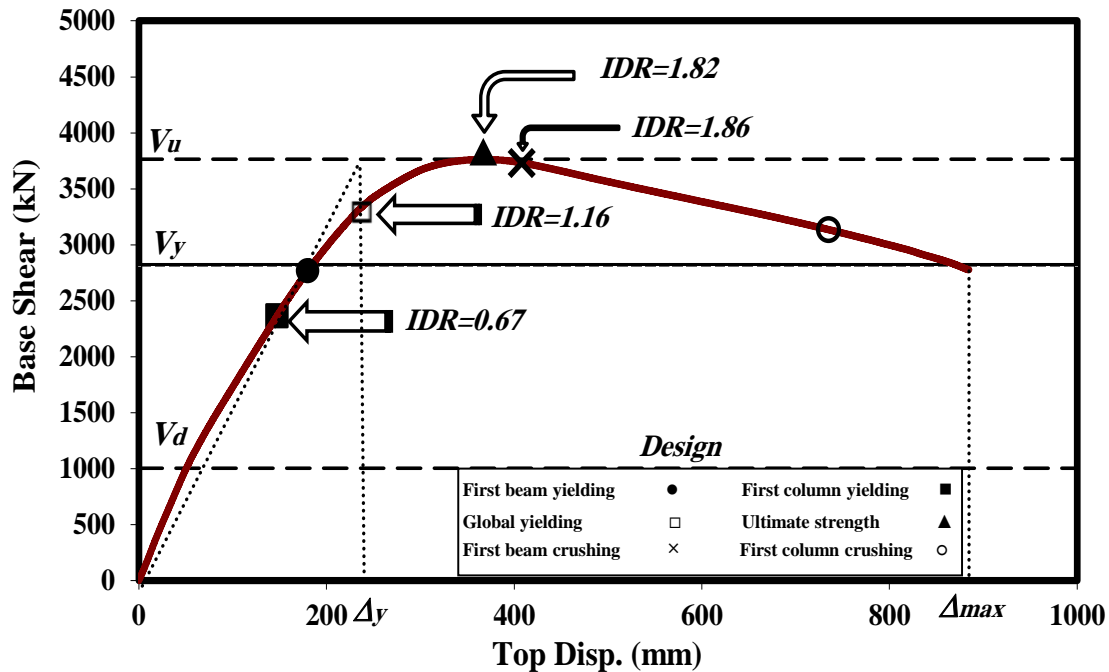

Figure 5: The capacity curves of the reference pre-code frame structure

## 5. DESIGN AND MODELLING OF STRENGTHENING TECHNIQUE

The 8-story pre-code structure lacked the strong-column weak-beam concept due to its inefficient lateral force design under wind loads only. Mapping the number and sequence of plastic hinges in vertical elements of the reference structure reflected the poor performance of this category of buildings. Far-field records have much higher impact on the reference structure over the near-source records. High IDRs are recorded in the pre-code frame structure at moderate-to-high ground motion intensity levels due to its inefficient lateral force resisting system. This increases the spread of plastic hinges in horizontal and vertical elements, leading to the formation of story mechanisms. At the design PGA, the reference structure exhibits high vulnerability. A large increase in the exceedance probabilities of various limit states is clear when the PGAs are doubled. The results reflect the urgent need of seismic retrofit for such pre-code structures to reduce their seismic losses (A. S. M. G. Issa, 2014).

Developed by Takeuchi et al. (2004) and produced and marketed by Nippon Steel Corporation, BRB has seen widespread use all around the world. This brace is essentially composed of concrete/grout filled steel tube and an inner steel core. The steel core is able to freely move inside the concrete sleeve thus reducing the possibility of axial load transfer from the core to the sleeve. When buckling load is reached the core steel is prevented from buckling by the strong concrete sleeve. In the present study, the BRB retrofit technique is applied to the 8-story pre-code reference building. BRBs are only added to the middle bays of the external frames. The axial force demands of the braces are obtained from the 3D design model. According to the design equation, the required steel core area to resist the entire axial force in the brace is  $2200\text{mm}^2$ . The test results reported by Tremblay et al. (2008) are adopted to model the BRBs. Figure 6a shows the load-deformation cyclic test of a BRB sub-assembly. A joint element with the trilinear asymmetric elasto-plastic curve is used to model the BRB (Figure 6b). Ten parameters are required to model the BRB, including different stiffness and displacement values that describe the tension-compression response (Elnashai et al., 2010).

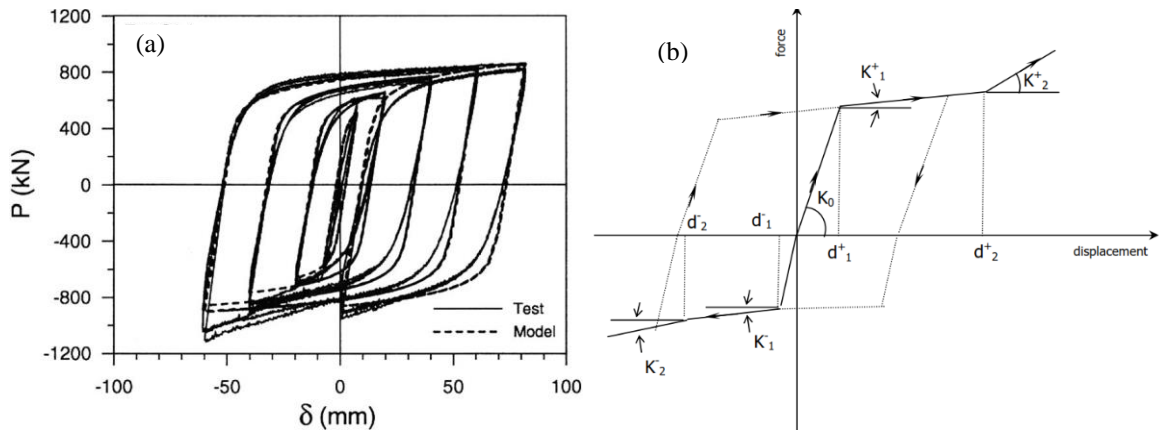

Figure 6. (a) Adopted BRB test result (Tremblay et al., 2008) (b) Trilinear asymmetric elasto-plastic model (Elnashai et al., 2010)

## 6. IMPACT OF RETROFIT ON SEISMIC PERFORMANCE

The obtained results indicate that the BRBs increase the overall lateral stiffness and strength, but result in reduced ductility due to the sudden failure in such retrofit technique when it reaches its ultimate axial capacity, as shown in Figure 7a. To overcome this issues, several researchers, such as (Haque & Alam, 2015), developed self-centring bracing systems that possess high ductility capacity. The fragility curves of the reference structures are developed before and after retrofit following the procedure adopted by A. Issa and Mwafy (2014a) and A. Mwafy et al. (2015). IDAs are performed using forty earthquake records representing two seismic scenarios for the study region. It is noteworthy that the fragility curves are developed using more than 1000 inelastic dynamic analyses undertaken for the retrofitted building. For each seismic scenario, 14 increments were adopted for far-field records starting from 0.5 times the design up to 7 times the design PGA, while the records of near source earthquakes were scaled from twice the design up to 14 times the design PGA.

In order to observe the performance enhancement, the fragility curves of both the original and retrofitted structures are plotted in Figure 7b. It is shown that the slopes of the fragilities become less steep for the retrofitted structure. The enhancements in the seismic performance of the retrofitted reference structure confirm the success of such retrofit technique to upgrade the seismic performance to reach the target levels and reduce the earthquake losses in the study area. The pre-code frame structures come as a top priority when implementing earthquake mitigation programs due to their wide spreading and high vulnerability in the study area.

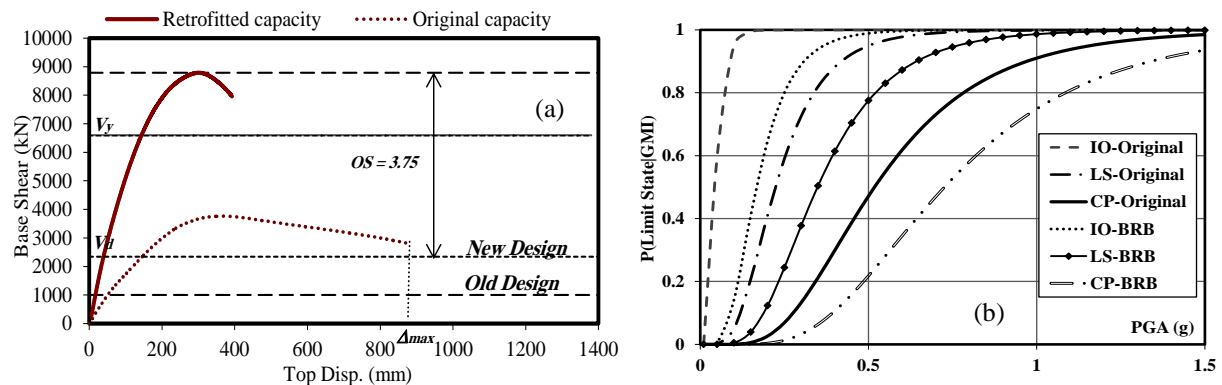

Figure 7. (a) Capacity curves of existing and retrofitted structure (b) Fragility relationships before and after retrofit using 20 long period records

A better comparison of the seismic performance of the original and retrofitted structure is achieved by comparing between the limit state exceedance probabilities of existing and retrofitted structures. Figure 8 depicts the Immediate Occupancy, Life Safety, and Collapse Prevention limit state exceedance probabilities before and after employing the rehabilitation technique for the retrofitted reference structure. The impact of the retrofit technique on the limit state exceedance probabilities varies among the different limit states. The results show the high reduction in the limit state exceedance probabilities for the BRB rehabilitation approach. The observed high improvement in the seismic performance of the pre-code frame structures is attributed to their original poor performance. The mentioned observation confirms the urgent need for the retrofitting of pre-code frame RC structures in the study area.

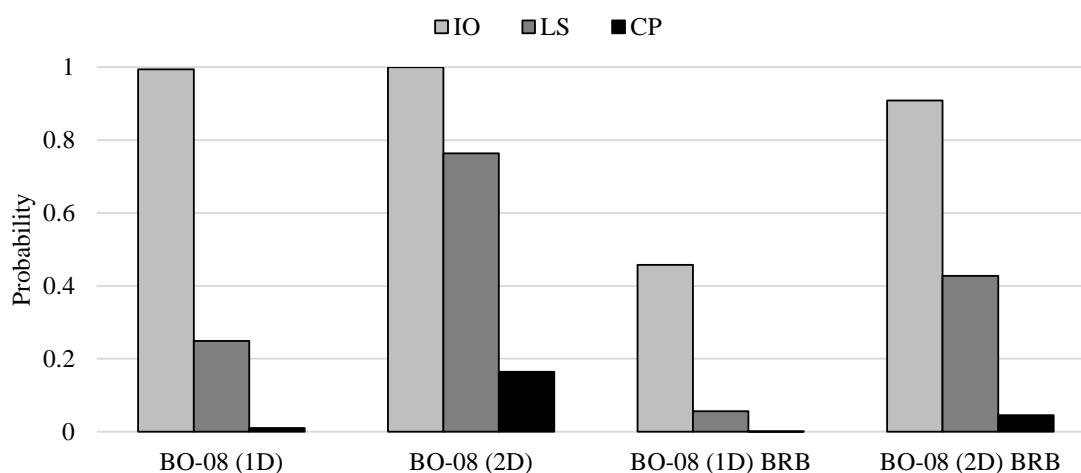

Figure 8. Limit States Probability of Exceedance for the reference building (BO-08) at the design intensity (1D) and twice the design intensity (2D).

## 7. CONCLUSIONS

Pre-code structures are of high priority in the potential consequences of natural hazard events since they represent high levels of vulnerability. This study enabled the derivation of simulation-based fragility relationships for a pre-seismic code frame building. The selection of 40 input ground motions representing the near-field and far-field earthquake scenarios anticipated in a highly populated seismically prone area of the UAE was briefly discussed. The limit state criteria employed for deriving fragility curves were selected based on the mapping of local and global response parameters from IPAs and IDAs as well as from previous studies. The vulnerability assessment study confirmed the vulnerability of pre-seismic code buildings to the far-field seismic scenario. The results reflected the urgent need of seismic retrofit for such pre-code structures to reduce their seismic losses. The investigated BRB retrofit technique was implemented in the external frames of the 8-story benchmark building to improve its seismic performance. Pushover and dynamic response simulations confirmed the effectiveness of such mitigation technique for reducing the seismic losses of pre-code frame buildings and increasing public safety in the study area.

## 8. REFERENCES

- ADIBC. (2013). Abu Dhabi International building code. Abu Dhabi, UAE.
- Ambraseys, N., Smit, P., Douglas, J., (...), & Costa, G. (2004). Internet site for European strong-motion data. *Bollettino di Geofisica Teorica ed Applicata*, 45(3), 113-129.
- BS8110, Structural use of concrete, British Standard Institution, London, UK, 1986.
- Elnashai, A. S., Papanikolaou, V., & Lee, D., Zeus-NL - A System for Inelastic Analysis of Structures - User Manual, University of Illinois at Urbana-Champaign, IL, 2012.



- FEMA-547, Techniques for the Seismic Rehabilitation of Existing Buildings, Federal Emergency Management Agency, , Washington, US, FEMA, 2006.
- Haque, A. R., & Alam, M. S. (2015). Cyclic Performance of a Piston Based Self-Centering Bracing System. In Structures Congress 2015 (pp. 2360-2371).
- Issa, A., Development of Simulation-based Fragility Relationships for the Seismic Risk Assessment of Buildings, MSc thesis, United Arab Emirates University, UAE, 2014.
- Issa, A., & Mwafy, A., Fragility assessment of pre-seismic code buildings and emergency facilities in the UAE. 2nd European Conference on Earthquake Engineering and Seismology, Istanbul, Turkey, 2014.
- Moehle, J. P., State of research on seismic retrofit of concrete building structures in the US, US-Japan symp. on seismic retrofit of concrete structures, Univ. of California, Berkeley, 2000.
- Mwafy, A. M., Classification and idealization of the building stock in the UAE for earthquake loss estimation, 15th World Conference on Earthquake Engrg., 2012.
- Mwafy, A. M., Elnashai, A. S., Sigbjornsson, R., & Salama, A., Significance of severe distant and moderate close earthquakes on design and behavior of tall buildings, The Structural Design of Tall and Special Buildings, 15(4), 391-416, 2006.
- Mwafy, A. M., Hussain, N., & El-Sawy, K., Seismic performance and cost-effectiveness of high-rise buildings with increasing concrete strength, The Structural Design of Tall and Special Buildings, 24(4), 257-279, 2015.
- Park, R. (1988). Ductility evaluation from laboratory and analytical testing. Paper presented at the Proceedings of the 9th world conference on earthquake engineering, Tokyo-Kyoto, Japan.
- PEER. (2013). PEER NGA database, <http://peer.berkeley.edu/nga>. Retrieved 01 October, 2013
- Takeuchi, T., Nakamura, H., Kimura, I., Hasegawa, H., Saeki, E., & Watanabe, A. (2004). Buckling restrained braces and damping steel structures: Google Patents.
- Tremblay, R., Lacerte, M., & Christopoulos, C. (2008). Seismic response of multistory buildings with self-centering energy dissipative steel braces. Journal of structural engineering, 134(1), 108-120.
- UBC. (1997). Uniform Building Code, Vol. 2. International Council of Building Officials, Whittier, CA.
- USGS. (2014). U.S. Geological Survey, <http://www.usgs.gov/> Retrieved 20 Aug., 2014.
- Yamamoto, Y., & Baker, J. W. (2013). Stochastic model for earthquake ground motion using wavelet packets. Bulletin of the Seismological Society of America, 103(6), 3044-3056.